

Log

Durbanis
2014

durbanis

Sizes in cm

Material: Concrete bench colored in mass. Wood surface with antitann and monocoat protection.

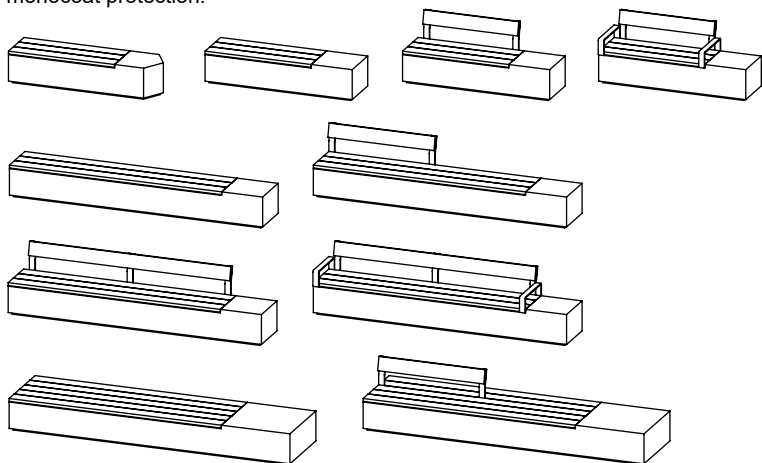

Placement system

Handling with long polyester slings.
Supported on the ground.

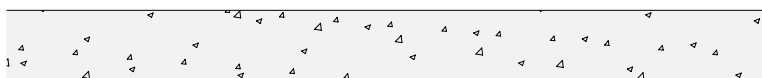
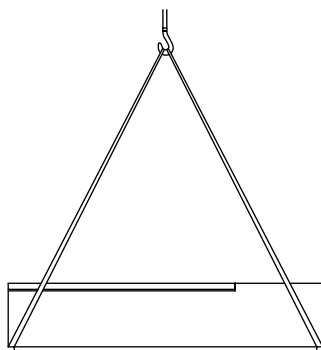

LOG 210 | weight 900kg.

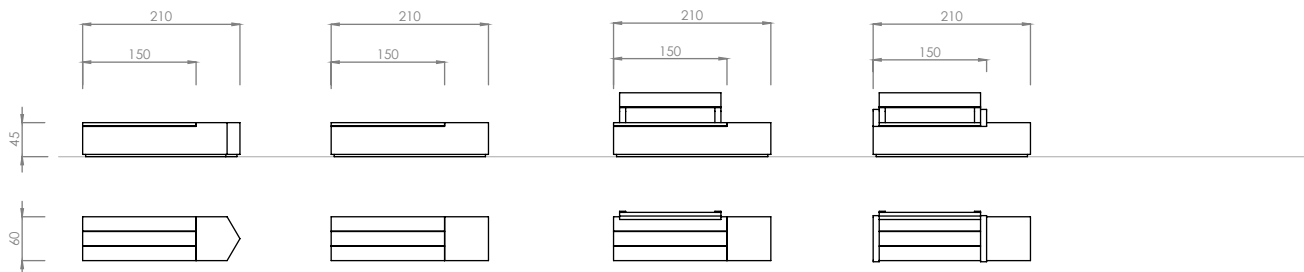

LOG 360 | weight 1.400kg.

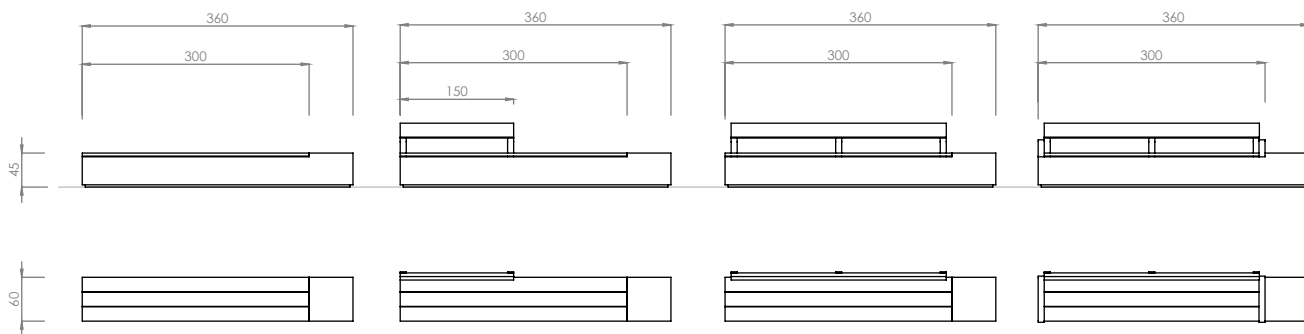

LOG 400 | weight 2.150kg.

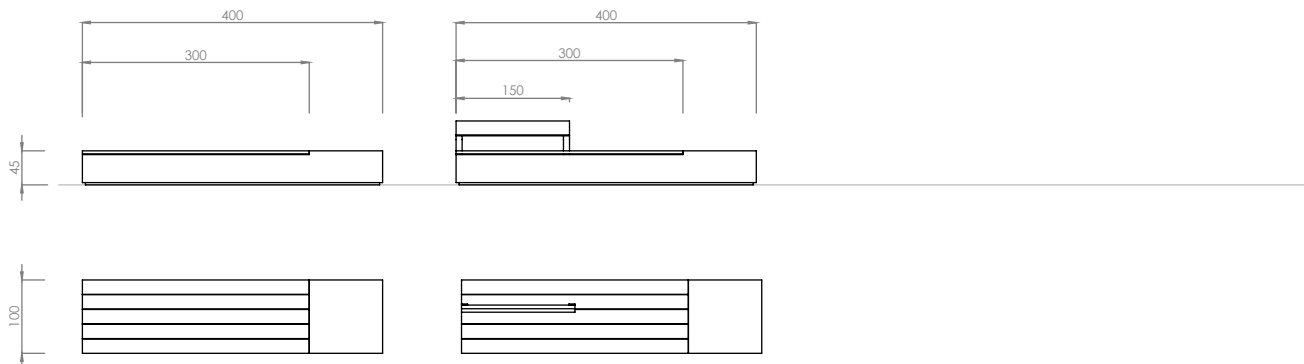

Log Beton

Durbanis
2014

durbanis

Sizes in cm

Material: Concrete bench colored in mass.

Weight: Log Cube 60, 400kg. / Log Corner, 300kg. / Log Cube 100, 700kg. / Log Line 210, 900kg. / Log Line 360, 1.400kg. / Log Line 400, 2.150kg.

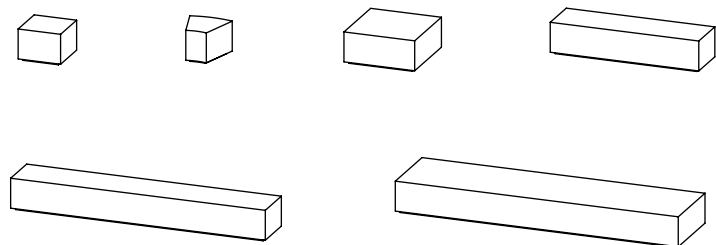

Placement system

Handling with long polyester slings.

Supported on the ground.

Log Cube 60 and Log Corner models have threaded bolts in the base, in case of needing extra fixation.

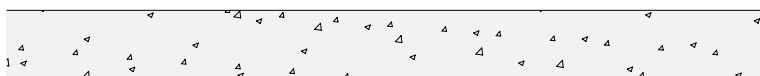
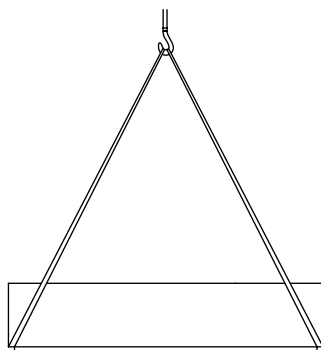

LOG CUBE 60

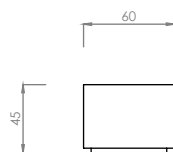

LOG CORNER

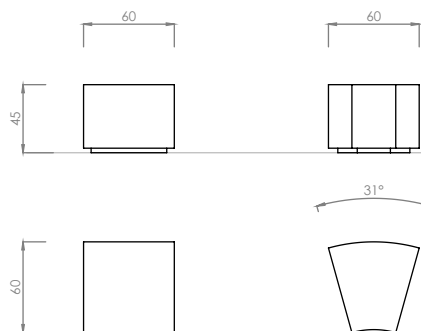

LOG CUBE 100

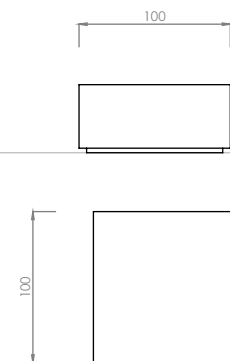

LOG LINE 210

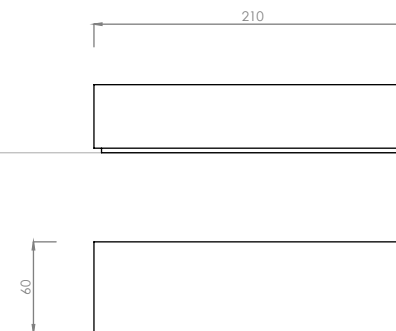

LOG LINE 360

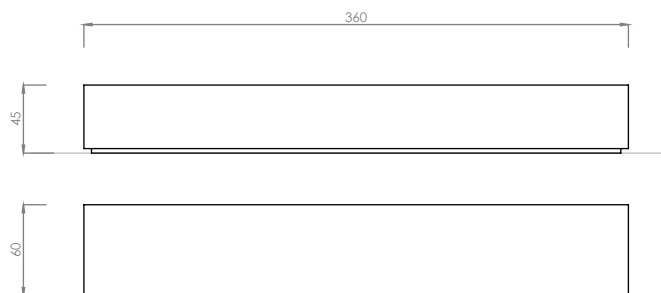

LOG LINE 400

