

Cinnamon-S

Durbanis
2017

durbanis

Sizes in cm

Material: Concrete bench colored in mass.

Weight: Cinnamon-S Straight 1.000kg / Cinnamon-S Curve 1.700kg. /

Cinnamon-S Arc 975kg. / Cinnamon-S Star 1.800kg

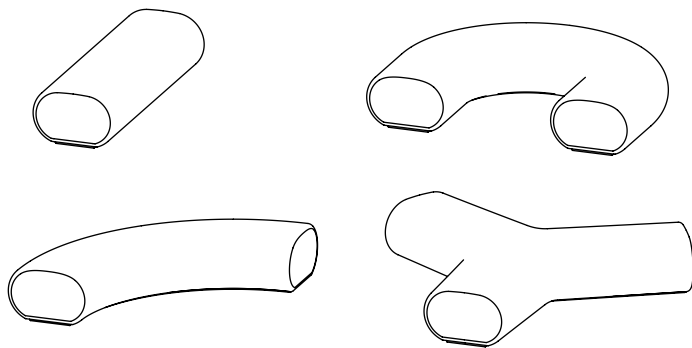

Placement system

Handling with long polyester slings.

Supported on the ground.

All models have a threaded bolts in the base, in case of needing extra fixation.

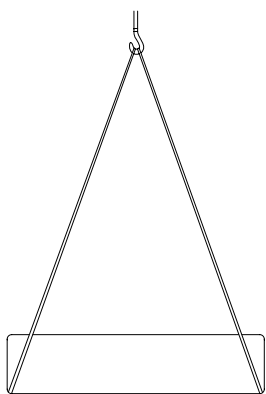

CINNAMON-S STRAIGHT

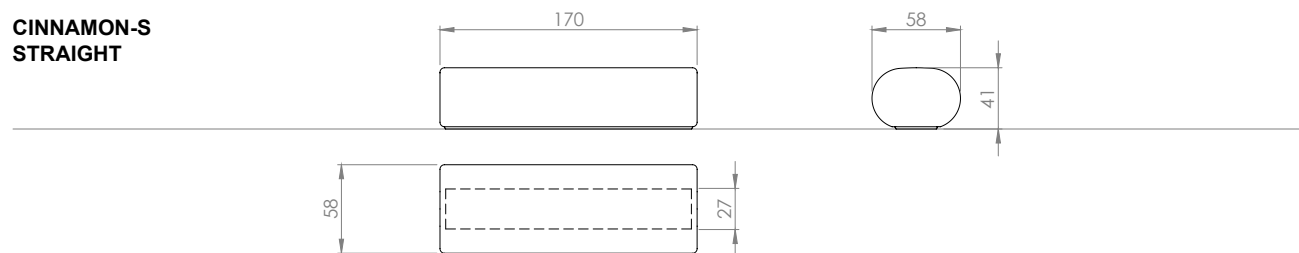

CINNAMON-S CURVE

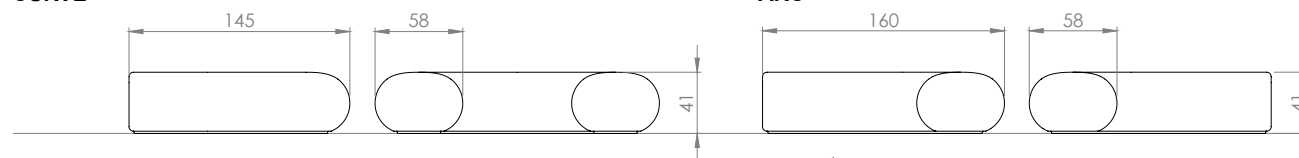

CINNAMON-S ARC

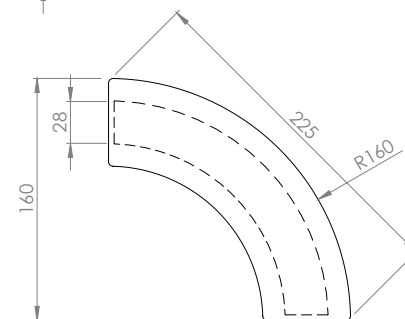
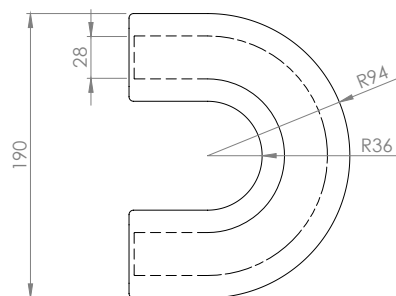
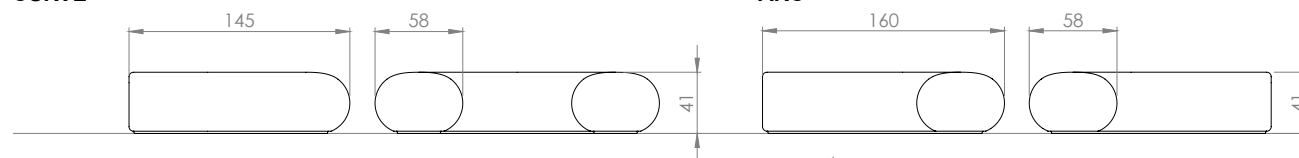

CINNAMON-S STAR

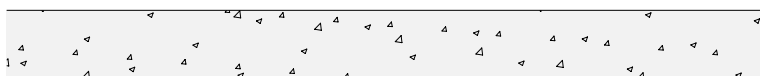
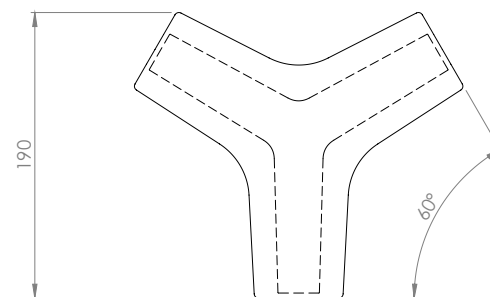
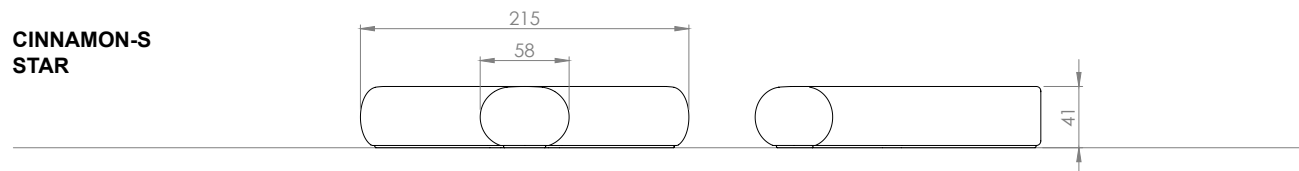

Cinnamon-L

Durbanis
2017

Sizes in cm

Material: Concrete bench colored in mass.

Weight: Cinnamon-L Straight 1.000kg / Cinnamon-L Arc 1.300kg. /

Cinnamon-L Star 2.300kg

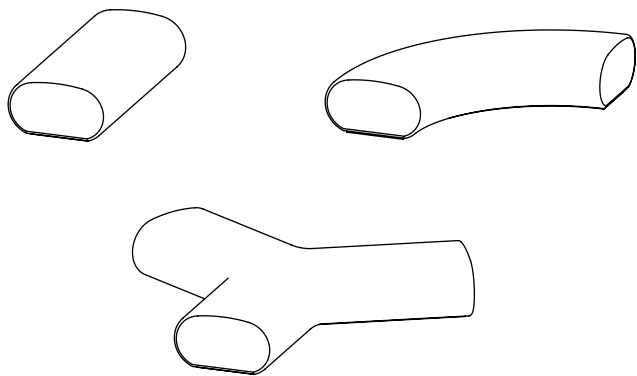

Placement system

Handling with long polyester slings.

Supported on the ground.

All models have a threaded bolts in the base, in case of needing extra fixation.

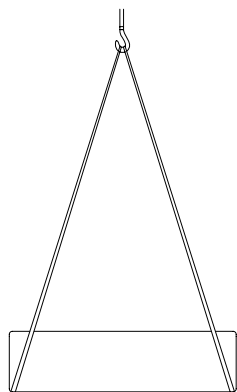

durbanis

CINNAMON-L STRAIGHT

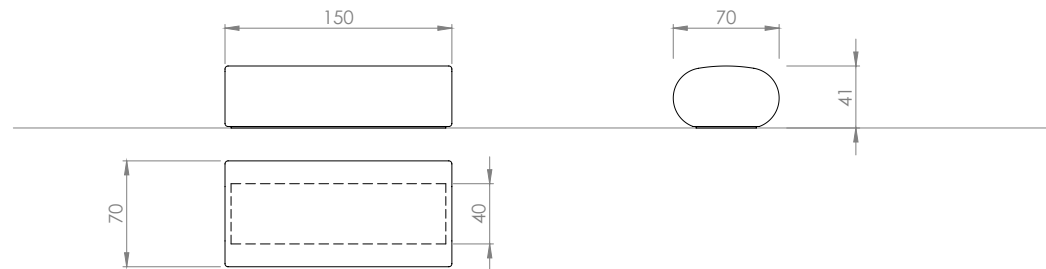

CINNAMON-L ARC

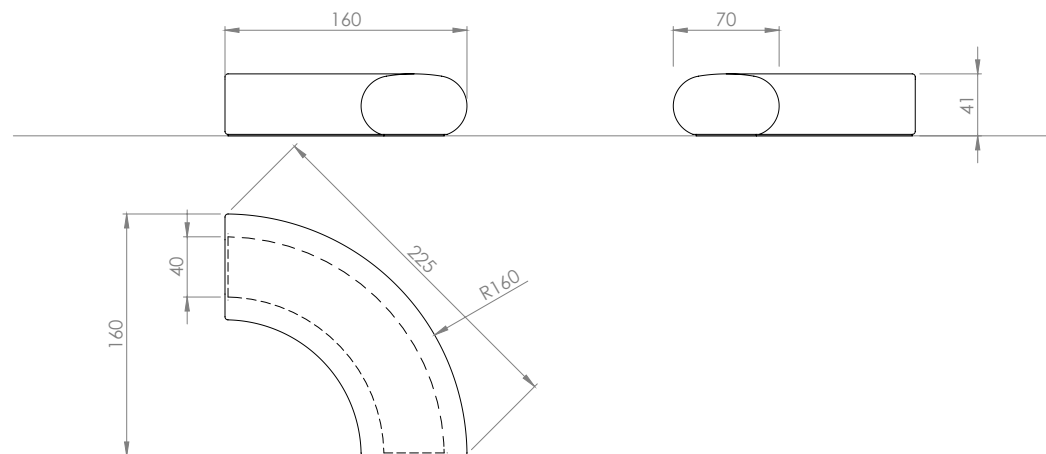

CINNAMON-L STAR

