

W600/3

Hanging Flower Tower

Specification

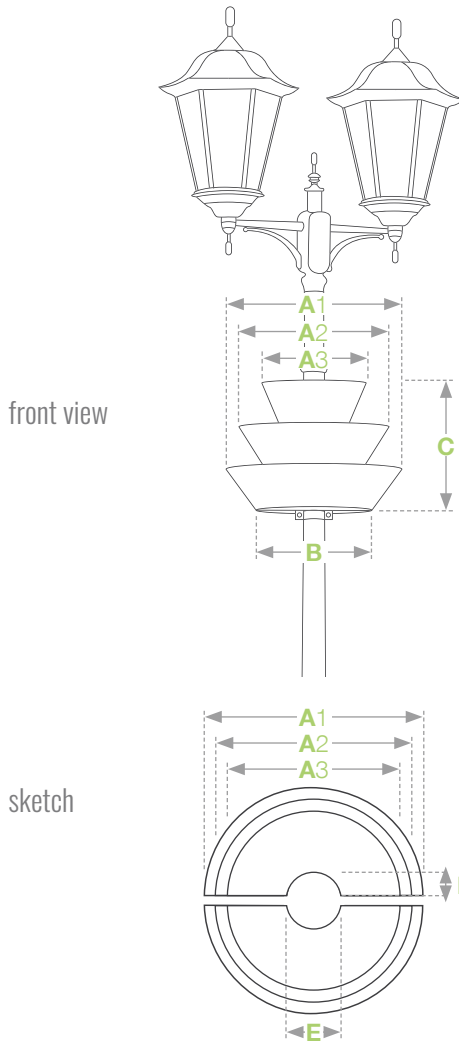







! BEWARE OF IMITATIONS!

It is impossible to copy quality and safety. Only branded products with the sign of Terra can provide the highest quality, safety and accuracy of workmanship.

 **Made in Europe**

 **24 month warranty**

- A1** Upper diameter of 1st level ▶ **600 mm**
- A2** Upper diameter of 2nd level ▶ **500 mm**
- A3** Upper diameter of 3rd level ▶ **400 mm**
- B** Bottom diameter ▶ **400 mm**
- C** Total height ▶ **475 mm**
- D** Inner radius ▶ **60 mm**
- E** Inner diameter ▶ **120 mm**

-  Number of rings ▶ **3**
-  Capacity of substrate ▶ **2 x 31 l**
-  Second bottom capacity ▶ **2 x 4 l**
-  Weight before planting ▶ **2 x 9 kg**
-  Weight of the planting ▶ **2 x 22-45 kg** 
-  Estimated amount of seedlings ▶ **2 x 10-14 items**

 Weight depends on the type of soil and its moisture

Terra Flower Tower construction is under a 2-year warranty program called „DOOR TO DOOR“. In fact, it is an extensive system of support and technical assistance, as well as an extremely efficient service guarantee. When a fault is detected in our products, service team fix it wherever you want or exchange the product with a new one.

Production method

- laser-cut rings
- MAG/TIG welded rings
- hot dip galvanized
- powder coated rings (DUPLEX system)

Colours

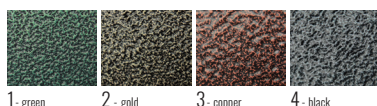

DUPLEX System

The combination of a galvanized layer and a polyester powder coat gives an extraordinary resistance. The top coat of paint, which supposed to be a decoration, becomes an additional anticorrosive layer.

Safety

- rubber seals on each ring
- no sharp edges
- high weight and stability
- high resistance to vandalism
- fixing to the ground (optional)

Assembly system

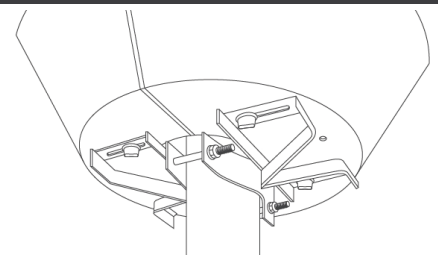

W600/3

Hanging Flower Tower

Transport

side view

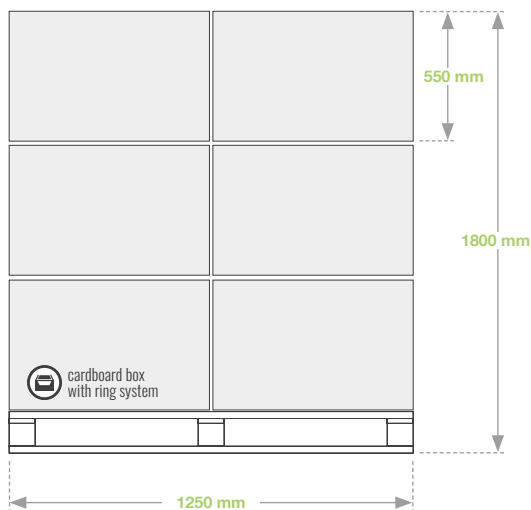

front view

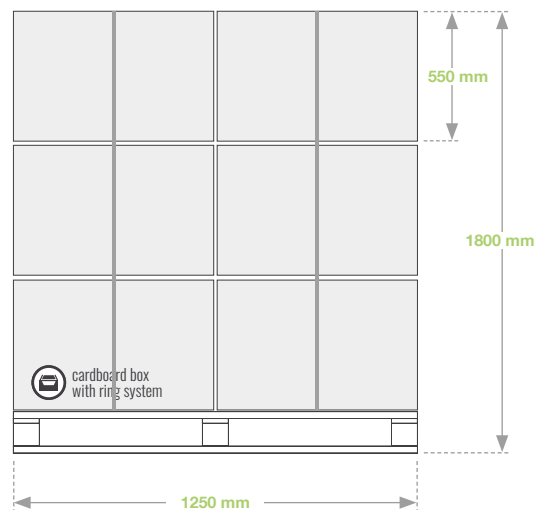

SET PACKED IN A CARDBOARD BOX UP TO 12 SETS ON A PALLET

Set contents

bottom fixing **A** (below 59 mm)
B (60 - 89 mm)

A rubber gasket	5 m
Fixing	1 kpl.
Screw 10 x 50	4 pcs
Wing screw 8 x 20	4 pcs

bottom fixing **C** (90 - 120 mm)

A rubber gasket	5 m
Fixing	1 kpl.
Screw 10 x 70	4 pcs
Wing screw 8 x 20	4 pcs

bottom fixing **D** (above 120 mm)

A rubber gasket	5 m
Fixing	1 kpl.
Screw 10 x 90	4 pcs
Wing screw 8 x 20	4 pcs

Additional Accessories

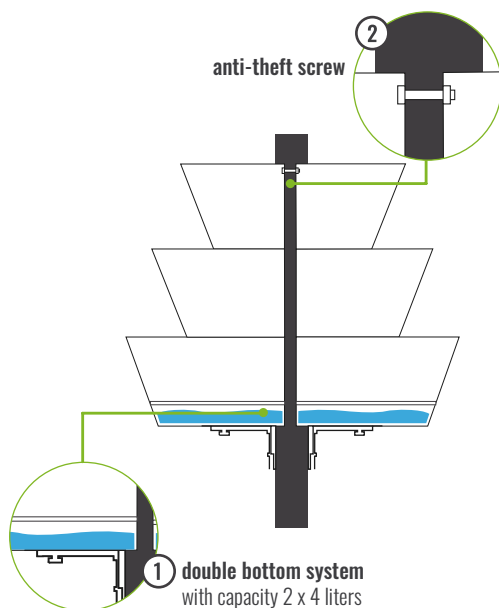

TerraClic k Tif

System montażowy

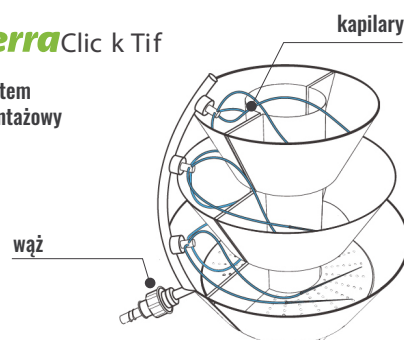

line number in the system
type of connectors
nominal flow of drippers
working pressure
anti-drip opening pressure
anti-drip closing pressure
hose type

- ▶ 3 verticals x 4 capillaries
- ▶ PP
- ▶ 2 - 4 l/h
- ▶ 0,5 - 4 atm
- ▶ 0,4 atm
- ▶ 0,2 atm
- ▶ new generation resistant to chemicals and acidification