

# Bibi

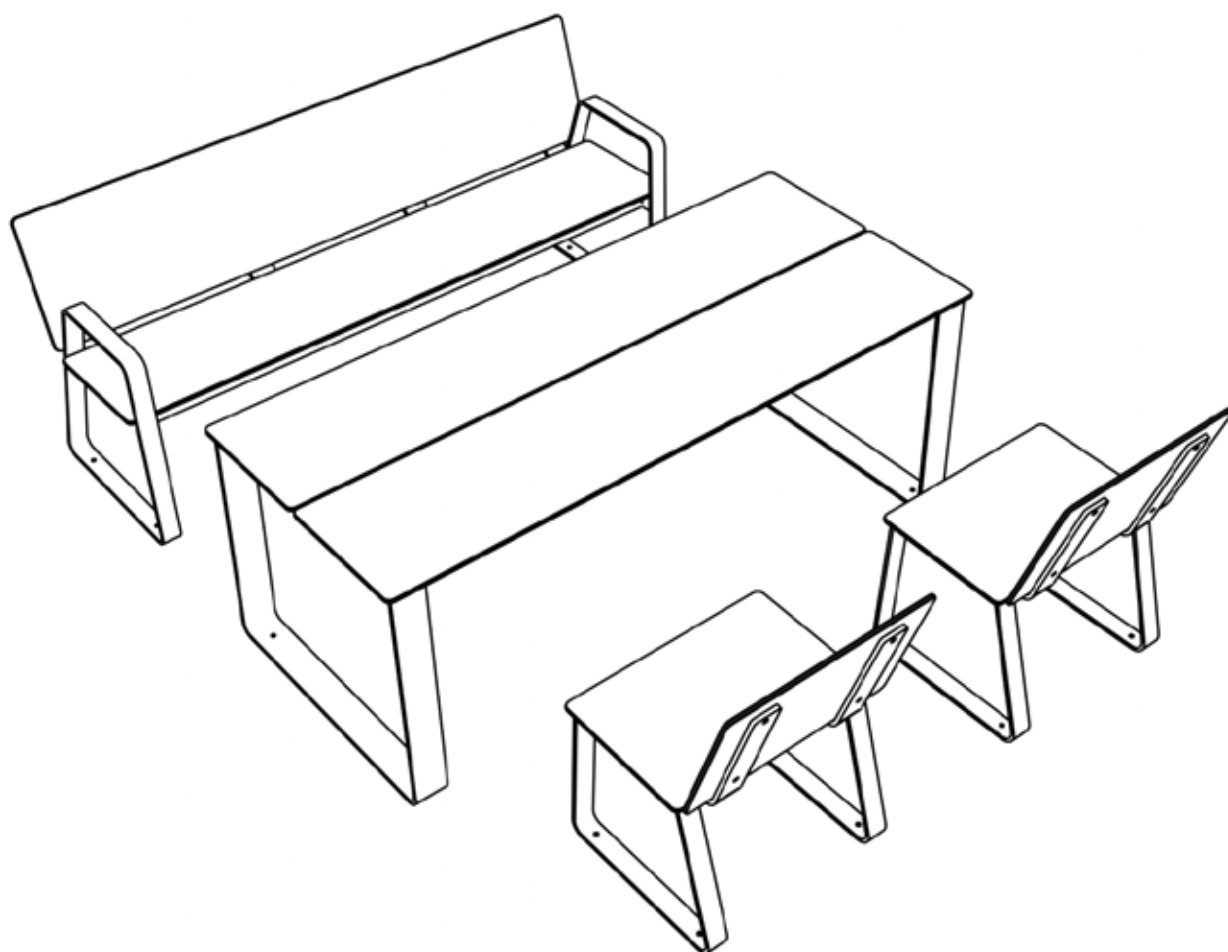

Bibi - Dimensions

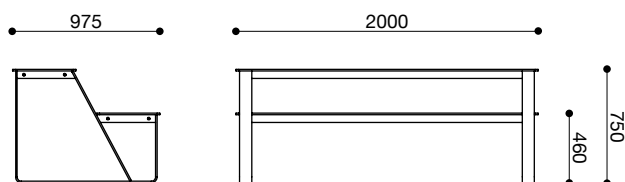
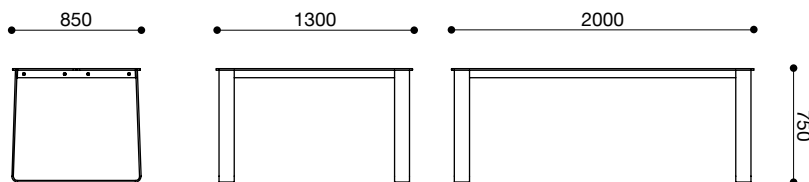
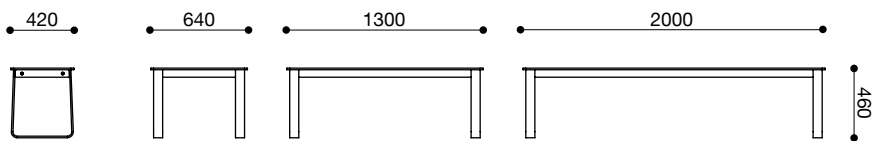
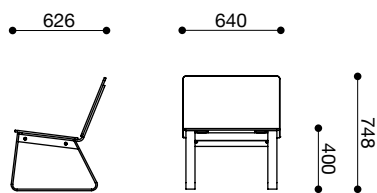
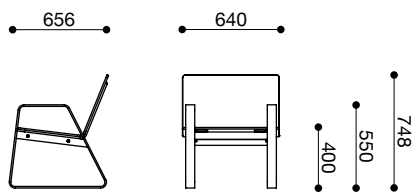
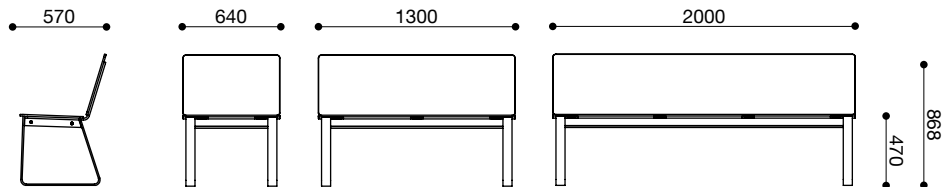
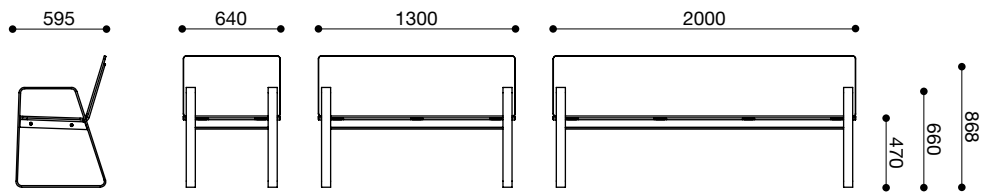

# Bibi - Dimensions for Ground Fixation

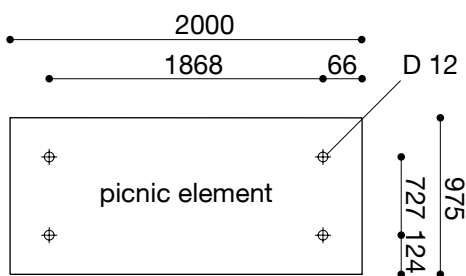
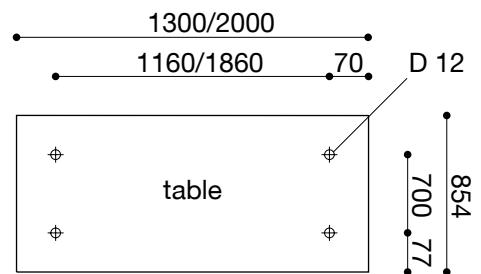
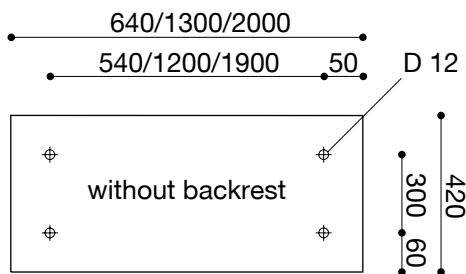
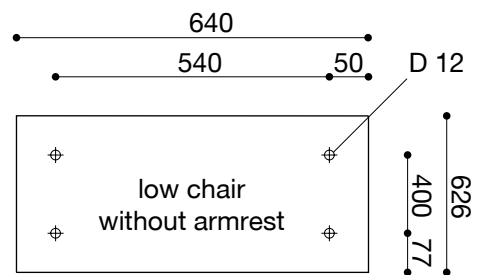
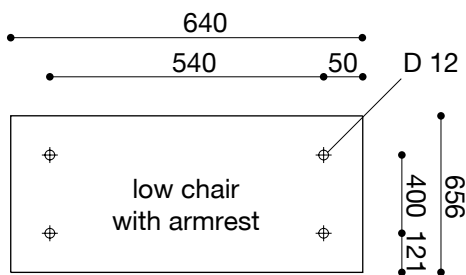
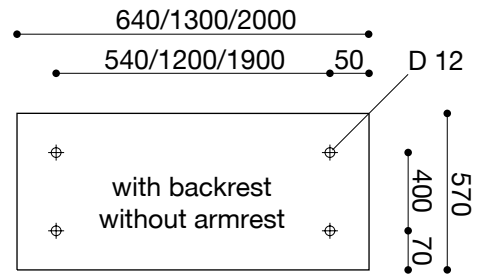
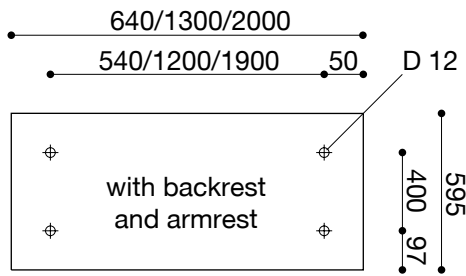

# Bibi - Options of Ground Fixation

## Without foundation with threaded rod

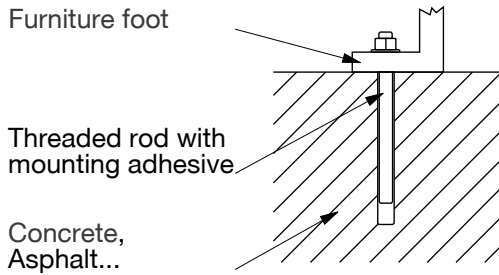

## With foundation with threaded rod

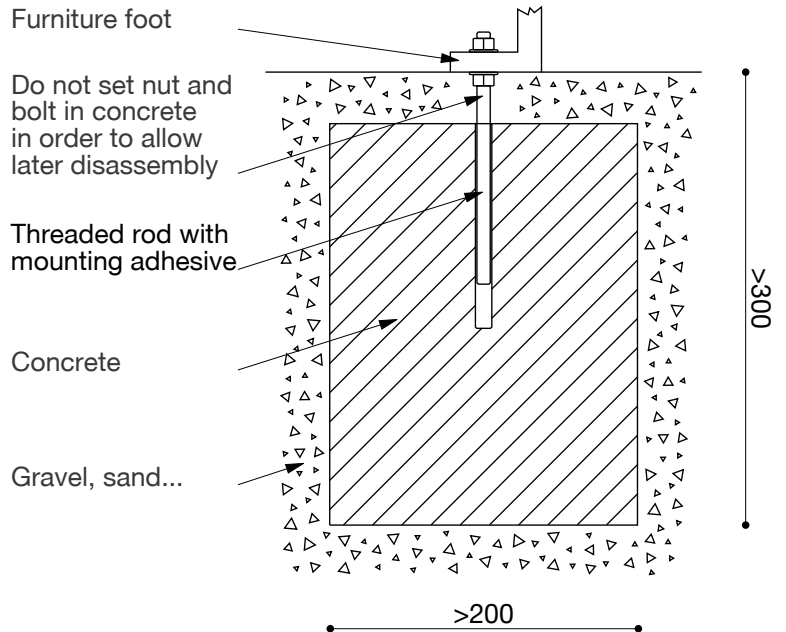

## Without foundation with screw and dowel

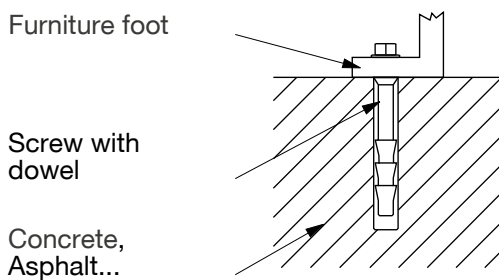

## With foundation with ground anchor

